

Heritage Shaker 1200mm Wall Hung Vanity Double Bowl

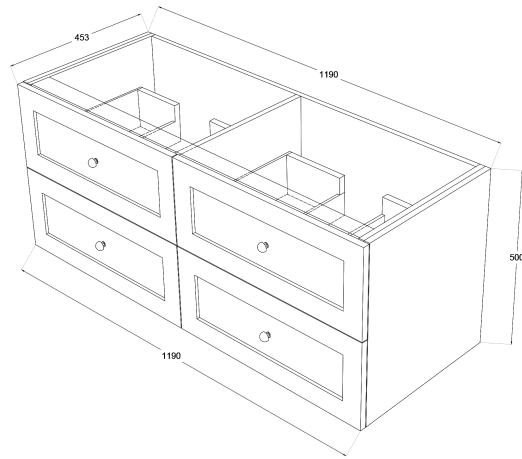

TOP VIEW: DRAWERS

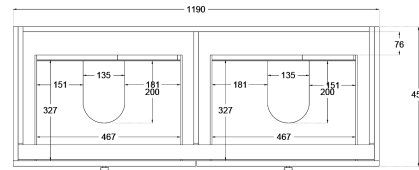

SIDE VIEW: DRAWER STORAGE

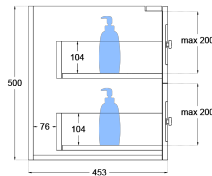



Product Specifications

- Code:** HER-1200-4DRW-DB-GS
- Finish:** Sage Green
- Primary Material:** White Melamine
- Technical Features:** Drawers: 4
Mounting: Wall Hung
Included: Double Bowl Vanity Stone
- Special Features:** Double Carcass
Standard White Stone
Soft Close
Hand Made



- 

HER-1200-4DRW-DB-TR
Tranquil Retreat
Polyurethane Spray Paint
- 

HER-1200-4DRW-DB-GS
Sage Green
Polyurethane Spray Paint
- 

HER-1200-4DRW-DB-FN
French Navy
Polyurethane Spray Paint
- 

HER-1200-4DRW-DB-MP
Matte Black
Polyurethane Spray Paint
- 

HER-1200-4DRW-DB-SW
Satin White
Polyurethane Spray Paint

Experience, *the difference.*



LINSOL.COM.AU

☎ 1300 546 765

@ info@linsol.com.au

✉ PO Box 88, Coniston NSW 2500

All information is correct at time of writing. The actual product may vary slightly and sizes may be scaled up or down. Warranty is for domestic use only. For warranty & care information please visit linsol.com.au/warranty