

# Heritage Shaker 1800mm Wall Hung Vanity Double Bowl

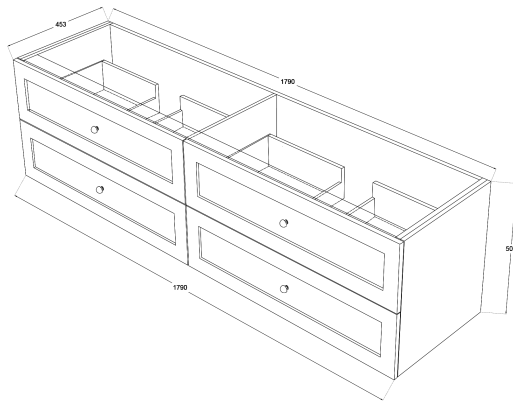

TOP VIEW: DRAWERS

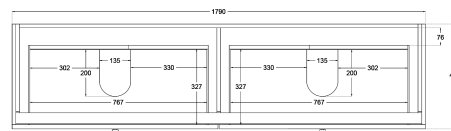

SIDE VIEW: DRAWER STORAGE

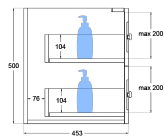



## Product Specifications

**Code:** HER-1800-4DRW-DB-SW  
**Finish:** Satin White  
**Primary Material:** White Melamine  
**Technical Features:** Drawers: 4  
 Mounting: Wall Hung  
 Included: Double Bowl Vanity Stone  
**Special Features:** Double Carcass  
 Standard White Stone  
 Soft Close  
 Hand Made



- 

**HER-1800-4DRW-DB-TR**  
*Tranquil Retreat*  
 Polyurethane Spray Paint
- 

**HER-1800-4DRW-DB-GS**  
*Sage Green*  
 Polyurethane Spray Paint
- 

**HER-1800-4DRW-DB-FN**  
*French Navy*  
 Polyurethane Spray Paint
- 

**HER-1800-4DRW-DB-MP**  
*Matte Black*  
 Polyurethane Spray Paint
- 

**HER-1800-4DRW-DB-SW**  
*Satin White*  
 Polyurethane Spray Paint

Experience, *the difference.*



LINSOL.COM.AU

☎ 1300 546 765

✉ info@linsol.com.au

✉ PO Box 88, Coniston NSW 2500

All information is correct at time of writing. The actual product may vary slightly and sizes may be scaled up or down. Warranty is for domestic use only. For warranty & care information please visit [linsol.com.au/warranty](http://linsol.com.au/warranty)