

Heritage Shaker 1800mm Wall Hung Vanity Double Bowl

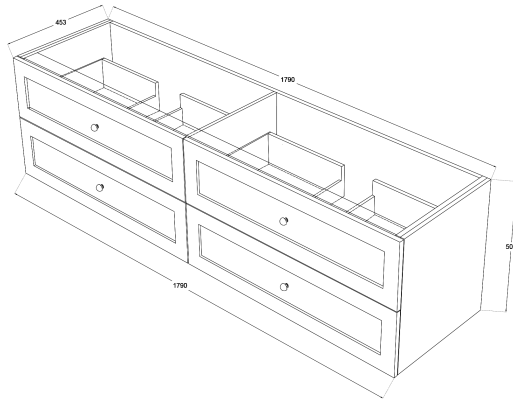

TOP VIEW: DRAWERS

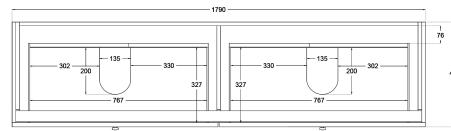

SIDE VIEW: DRAWER STORAGE

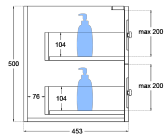



Product Specifications

Code: HER-1800-4DRW-DB-TR
Finish: Tranquil Retreat
Primary Material: White Melamine
Technical Features: Drawers: 4
 Mounting: Wall Hung
 Included: Double Bowl Vanity Stone
Special Features: Double Carcass
 Standard White Stone
 Soft Close
 Hand Made



- 

HER-1800-4DRW-DB-TR
Tranquil Retreat
 Polyurethane Spray Paint
- 

HER-1800-4DRW-DB-GS
Sage Green
 Polyurethane Spray Paint
- 

HER-1800-4DRW-DB-FN
French Navy
 Polyurethane Spray Paint
- 

HER-1800-4DRW-DB-MP
Matte Black
 Polyurethane Spray Paint
- 

HER-1800-4DRW-DB-SW
Satin White
 Polyurethane Spray Paint

Experience, *the difference.*



LINSOL.COM.AU

☎ 1300 546 765

@ info@linsol.com.au

✉ PO Box 88, Coniston NSW 2500

All information is correct at time of writing. The actual product may vary slightly and sizes may be scaled up or down. Warranty is for domestic use only. For warranty & care information please visit linsol.com.au/warranty