

# Heritage Shaker 750mm Wall Hung Vanity

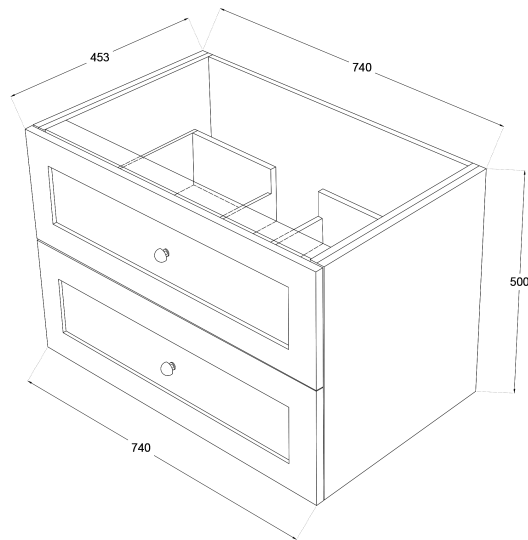

TOP VIEW: DRAWERS

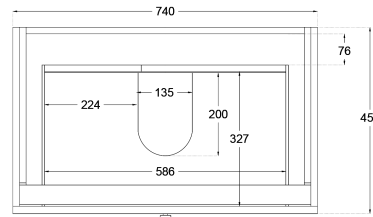

SIDE VIEW:  
DRAWER STORAGE

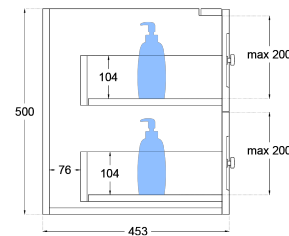



## Product Specifications

**Code:** HER-750-2DRW-FN  
**Finish:** French Navy  
**Primary Material:** White Melamine  
**Technical Features:** Drawers: 2  
 Mounting: Wall Hung  
 Included: Single Bowl Vanity Stone  
 Double Carcass  
 Standard White Stone  
**Special Features:** Soft Close  
 Hand Made



- 

**HER-750-2DRW-TR**  
*Tranquil Retreat*  
 Polyurethane Spray Paint
- 

**HER-750-2DRW-GS**  
*Sage Green*  
 Polyurethane Spray Paint
- 

**HER-750-2DRW-FN**  
*French Navy*  
 Polyurethane Spray Paint
- 

**HER-750-2DRW-MB**  
*Matte Black*  
 Polyurethane Spray Paint
- 

**HER-750-2DRW-SW**  
*Satin White*  
 Polyurethane Spray Paint

Experience, *the difference.*



LINSOL.COM.AU

☎ 1300 546 765

@ info@linsol.com.au

✉ PO Box 88, Coniston NSW 2500

All information is correct at time of writing. The actual product may vary slightly and sizes may be scaled up or down. Warranty is for domestic use only. For warranty & care information please visit [linsol.com.au/warranty](http://linsol.com.au/warranty)