

Heritage Shaker 900mm Wall Hung Vanity

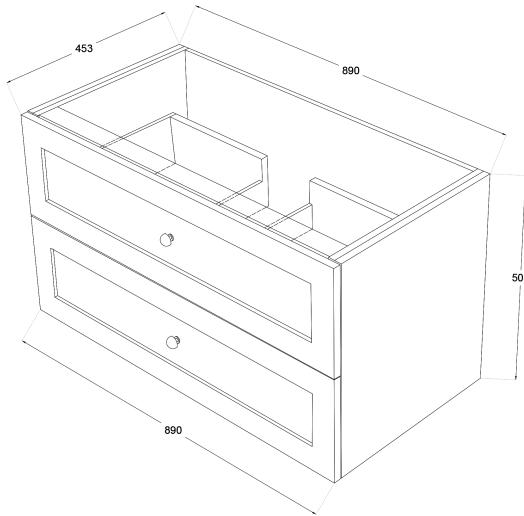

Product Specifications

Code: HER-900-2DRW-GS
Finish: Sage Green
Primary Material: White Melamine
Technical Features: Drawers: 2
Mounting: Wall Hung
Included: Single Bowl Vanity Stone
Special Features: Double Carcass
Standard White Stone
Soft Close
Hand Made





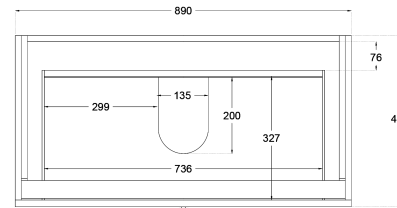

TOP VIEW: DRAWERS

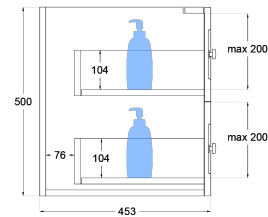

SIDE VIEW:
DRAWER STORAGE



- | | | | | | |
|---|---|---|--|---|--|
|  | HER-900-2DRW-TR
<i>Tranquil Retreat</i>
Polyurethane Spray Paint |  | HER-900-2DRW-GS
<i>Sage Green</i>
Polyurethane Spray Paint |  | HER-900-2DRW-FN
<i>French Navy</i>
Polyurethane Spray Paint |
|  | HER-900-2DRW-MB
<i>Matte Black</i>
Polyurethane Spray Paint |  | HER-900-2DRW-SW
<i>Satin White</i>
Polyurethane Spray Paint | | |

Experience, *the difference.*



LINSOL.COM.AU

☎ 1300 546 765

✉ info@linsol.com.au

✉ PO Box 88, Coniston NSW 2500

All information is correct at time of writing. The actual product may vary slightly and sizes may be scaled up or down. Warranty is for domestic use only. For warranty & care information please visit linsol.com.au/warranty