

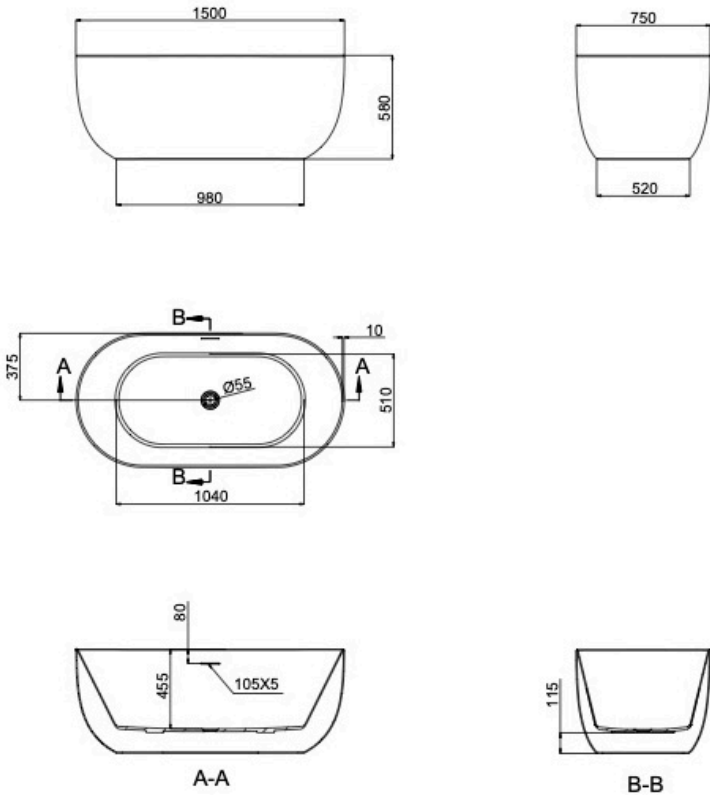







Nora 1500mm Freestanding Bath with Overflow



Product Specifications

Code: NOR-FS-OF150-MB
Finish: Matte Black
Barcode: 9339897009911
Primary Material: Sanitary Grade Acrylic
Technical Features: Mounting: Freestanding
 Pop-up Waste Sold Separately



- | | | |
|--|--|---|
|  NOR-FS-OF150-WG
Warm Grey
Layered Acrylic |  NOR-FS-OF150-SG
Sage Green
Layered Acrylic |  NOR-FS-OF150-OO
Outback Orange
Layered Acrylic |
|  NOR-FS-OF150-MW
Matte White
Layered Acrylic |  NOR-FS-OF150-MB
Matte Black
Layered Acrylic |  NOR-FS-OF150-GB
Grey Blue
Layered Acrylic |
|  NOR-FS-OF150-GW
Gloss White
Layered Acrylic |  NOR-FS-OF150-G
Ginger
Layered Acrylic | |

Experience, *the difference.*



LINSOL.COM.AU

☎ 1300 546 765

✉ info@linsol.com.au

✉ PO Box 88, Coniston NSW 2500

All information is correct at time of writing. The actual product may vary slightly and sizes may be scaled up or down. Warranty is for domestic use only. For warranty & care information please visit linsol.com.au/warranty