

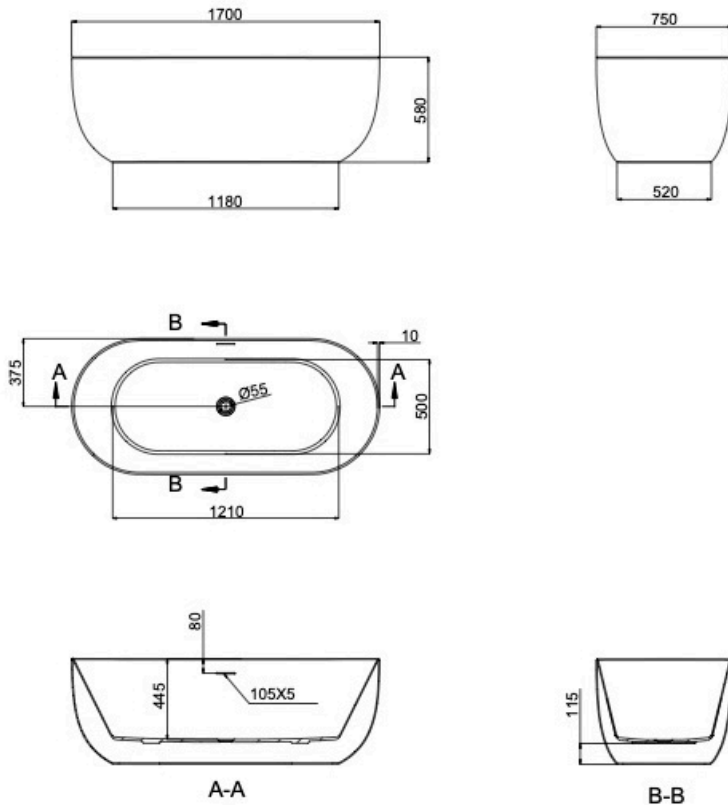







# Nora 1700mm Freestanding Bath with Overflow



## Product Specifications

**Code:** NOR-FS-OF170-G  
**Finish:** Ginger  
**Barcode:** 9339897009966  
**Primary Material:** Sanitary Grade Acrylic  
**Technical Features:** Mounting: Freestanding  
 Pop-up Waste Sold Separately



- |                                                                                                                                                        |                                                                                                                                                     |                                                                                                                                                     |
|--------------------------------------------------------------------------------------------------------------------------------------------------------|-----------------------------------------------------------------------------------------------------------------------------------------------------|-----------------------------------------------------------------------------------------------------------------------------------------------------|
|  <b>NOR-FS-OF170-G</b><br><i>Ginger</i><br>Layered Acrylic          |  <b>NOR-FS-OF170-WG</b><br><i>Warm Grey</i><br>Layered Acrylic   |  <b>NOR-FS-OF170-SG</b><br><i>Sage Green</i><br>Layered Acrylic  |
|  <b>NOR-FS-OF170-OO</b><br><i>Outback Orange</i><br>Layered Acrylic |  <b>NOR-FS-OF170-MW</b><br><i>Matte White</i><br>Layered Acrylic |  <b>NOR-FS-OF170-MB</b><br><i>Matte Black</i><br>Layered Acrylic |
|  <b>NOR-FS-OF170-GW</b><br><i>Gloss White</i><br>Layered Acrylic    |  <b>NOR-FS-OF170-GB</b><br><i>Grey Blue</i><br>Layered Acrylic   |                                                                                                                                                     |

Experience, *the difference.*



LINSOL.COM.AU

☎ 1300 546 765

✉ info@linsol.com.au

✉ PO Box 88, Coniston NSW 2500

All information is correct at time of writing. The actual product may vary slightly and sizes may be scaled up or down. Warranty is for domestic use only. For warranty & care information please visit [linsol.com.au/warranty](http://linsol.com.au/warranty)